

## INTRODUCTION

Thank you for choosing an HK Instruments DPT-Flow series air flow transmitter. The DPT-Flow series is intended for use in commercial environments. The DPT-Flow measures air flow, velocity and differential pressure. It is designed to be used in combination with air flow measuring probes (i.e. FloXact), dampers or with centrifugal fans that provide differential pressure connections and K-values.

The DPT-Flow series of air flow transmitters is comprised of DPT-Flow-1000, DPT-Flow-2000, DPT-Flow-5000 and DPT-Flow-7000 with measurement ranges of 0-1000 Pa, 0-2000 Pa, 0-5000 Pa and 0-7000 Pa respectively. All models come with display and manual pushbutton zero point calibration. Optional autozero calibration is also available.

## APPLICATIONS

DPT-Flow series devices are commonly used in HVAC/R systems for:

- air flow monitoring across centrifugal fans and blowers
- in-duct air flow monitoring
- VAV applications

## SPECIFICATIONS

### Performance

#### Accuracy (from applied pressure):

Models 1000 and 2000:

- Pressure < 125 Pa = 1 % + ±2 Pa
- Pressure > 125 Pa = 1 % + ±1 Pa

Models 5000 and 7000:

- Pressure < 125 Pa = 1.5 % + ±2 Pa
- Pressure > 125 Pa = 1.5 % + ±1 Pa

(Accuracy specifications include: general accuracy, temperature drift, linearity, hysteresis, long term stability, and repetition error)

#### Thermal effects:

Temperature compensated across the full spectrum of capability

#### Overpressure:

Proof pressure: 25 kPa  
Burst pressure: 30 kPa

#### Zero point calibration:

Automatic autozero or manual pushbutton

#### Response time:

1.0-20 s, selectable via menu

### Technical Specifications

#### Media compatibility:

Dry air or non-aggressive gases

#### Pressure units (select via menu):

Pa, kPa, mbar, inWC, mmWC, psi

#### Pressure output scale (select via menu):

	DPT-Flow-1000	DPT-Flow-2000	DPT-Flow-5000	DPT-Flow-7000
Pa	100-1,000	200-2,000	500-5,000	700-7,000
kPa	0.1-1.0	0.2-2.0	0.5-5.0	0.7-7.0
mbar	1-10	2.0-20	5.0-50	7.0-70
mmWC	10-100	20-200	50-500	70-700
inWC	0.4-4.0	0.8-8.0	2.0-20	2.5-30

#### Flow units (select via menu):

Volume: m<sup>3</sup>/s, m<sup>3</sup>/hr, cfm, l/s, none

Velocity: m/s, ft/min

#### Flow output scale (select via menu):

Units	Range
m <sup>3</sup> /s	0.025-50
m <sup>3</sup> /hr	100-200,000
cfm	50-100,000
l/s	25-50,000
m/s	1-100
f/min	200-20,000

#### Measuring element:

MEMS

#### Environment:

Operating temperature: -10...50 °C,  
with autozero (-AZ) calibration -5...50 °C  
Storage temperature: -20...70 °C  
Humidity: 0 to 95 % rH, non condensing

### Physical

#### Dimensions:

Case: 90.0 x 95.0 x 36.0 mm

#### Weight:

150 g

#### Mounting:

2 each 4.3 mm screw holes, one slotted

#### Materials:

Case: ABS

Lid: PC

Duct connectors: ABS

Tubing: PVC

#### Protection standard:

IP54

## WARNING

- READ THESE INSTRUCTIONS CAREFULLY BEFORE ATTEMPTING TO INSTALL, OPERATE OR SERVICE THIS DEVICE.
- Failure to observe safety information and comply with instructions can result in PERSONAL INJURY, DEATH AND/OR PROPERTY DAMAGE.
- To avoid electrical shock or damage to equipment, disconnect power before installing or servicing and use only wiring with insulation rated for full device operating voltage.
- To avoid potential fire and/or explosion do not use in potentially flammable or explosive atmospheres.
- Retain these instructions for future reference.
- This product, when installed, will be part of an engineered system whose specifications and performance characteristics are not designed or controlled by HK Instruments. Review applications and national and local codes to assure that the installation will be functional and safe. Use only experienced and knowledgeable technicians to install this device.

### Display

2-line display (12 characters/line)

Line 1: Volume or velocity measurement

Line 2: Pressure measurement

Size: 46.0 x 14.5 mm

#### Electrical connections:

4-screw terminal block

Wire: 0.2-1.5 mm<sup>2</sup> (12-24 AWG)

#### Cable entry:

Strain relief: M16

Knockout: 16 mm

#### Pressure fittings

Male ø 5.0 mm and 6.3 mm

### Electrical

#### Voltage:

Circuit: 3-wire (V Out, 24 V, GND)

Input: 24 VAC or VDC, ±10 %

Output: 0-10 V, selectable via jumper

Power consumption: <1.0 W

Resistance minimum: 1 kΩ

#### Current:

Circuit: 3-wire (mA Out, 24 V, GND)

Input: 24 VAC or VDC, ±10 %

Output: 4-20 mA, selectable via jumper

Power consumption: <1.2 W

Maximum load: 500 Ω

Minimum load: 20 Ω

### Conformance

Meets requirements for CE marking:

EMC Directive 2014/30/EU

RoHS Directive 2011/65/EU

WEEE Directive 2012/19/EU

COMPANY WITH  
MANAGEMENT SYSTEM  
CERTIFIED BY DNV GL  
= ISO 9001 = ISO 14001 =



## SCHEMATICS

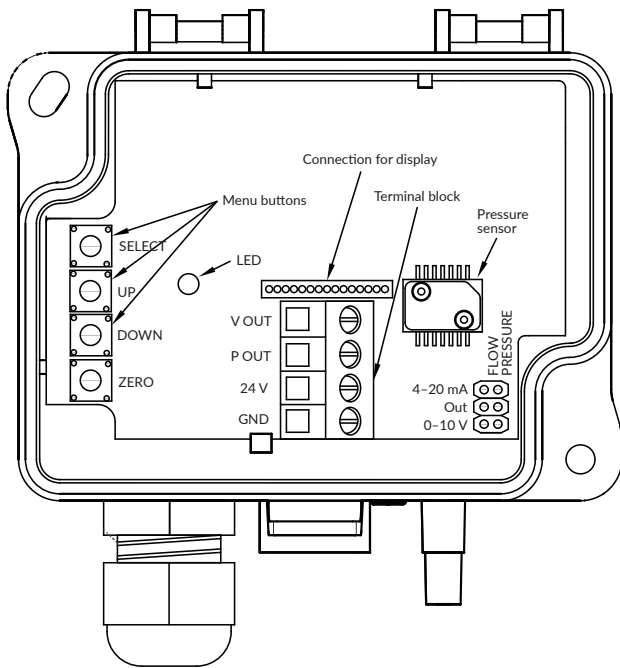

## DIMENSIONAL DRAWINGS

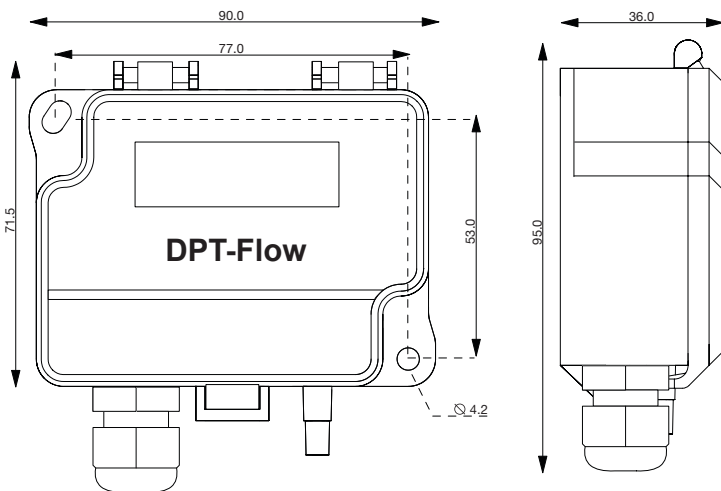

## INSTALLATION

- 1) Mount the device in the desired location (see step 1).
- 2) Open the lid and route the cable through the strain relief and connect the wires to the terminal block(s) (see step 2).
- 3) The device is now ready for configuration.

**⚠ WARNING!** Apply power only after the device is properly wired.

## STEP 1: MOUNTING THE DEVICE

- 1) Select the mounting location (duct, wall, panel).
- 2) Use the device as a template and mark the screw holes.
- 3) Mount with appropriate screws.

**Figure 1a - Surface mounting**

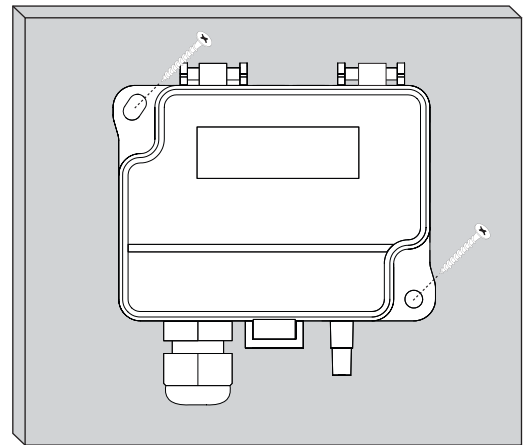

**Figure 1b - Mounting orientation**

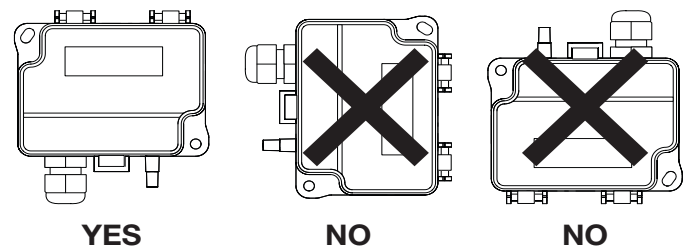

**Figure 1c - Application connections**

The pressure tubes are connected to a flow measurement probe (i.e. FloXact), or to the measurement ports specified by the fan manufacturer. Please see the FloXact installation guide or the fan manufacturer's technical specifications for more information.

## STEP 2: WIRING DIAGRAMS

For CE compliance, a properly grounded shielding cable is required.

- 1) Unscrew the strain relief and route the cable.
- 2) Connect the wires as shown in figure 2a and 2b.
- 3) Tighten the strain relief.

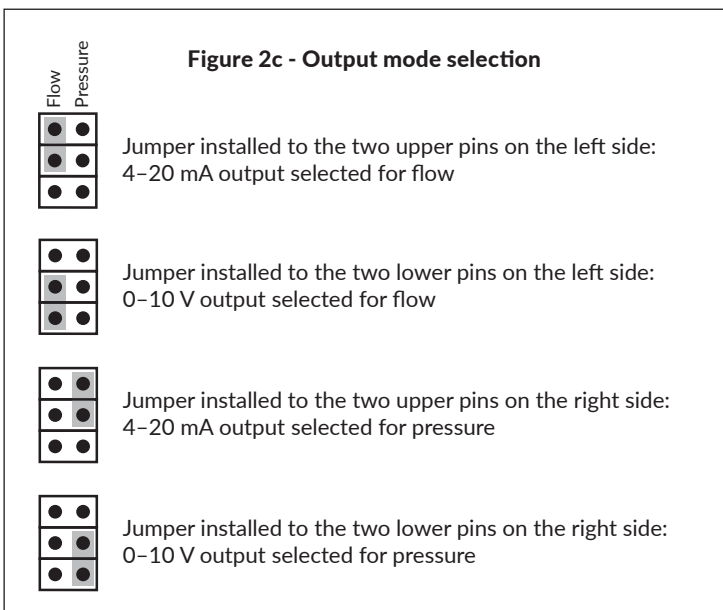
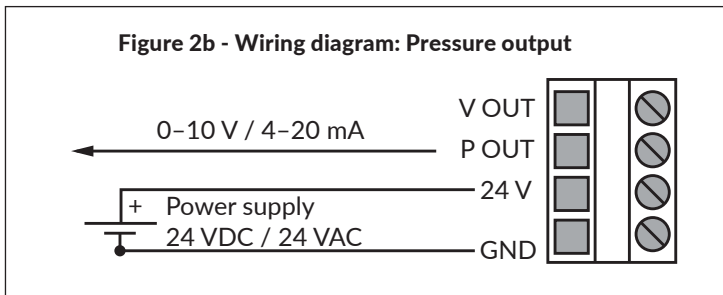
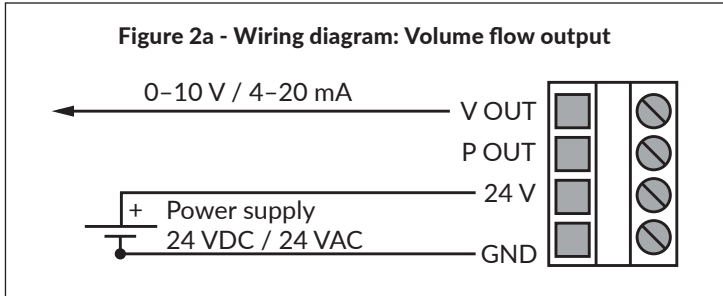

## STEP 3: CONFIGURATION

- 1) Select the functioning mode of the flow meter:
  - Select *Manufacturer* when connecting DPT-Flow to a fan with pressure measurement points
  - Select *Common probe* when using DPT-Flow with a common measurement probe that follows the formula:  $q = k \cdot \sqrt{\Delta P}$  (i.e. FloXact)

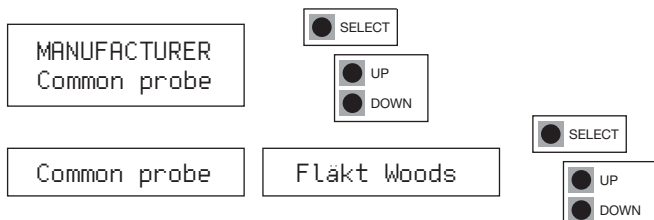

## CONFIGURATION CONTINUED

- 2) If *Common probe* selected: select measurement units used in the formula (aka Formula unit) (i.e. l/s)

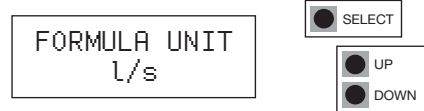

- 3) Select K-value

- a. If manufacturer selected in step 1:

Each fan has a specific K-value. Select the K-value from fan manufacturer's specifications.

Manufacturer:	K-value:
Fläktwoods	k = 0,3...99
Rosenberg	k = 37...800
Nicotra	k = 10...1500
Comefri	k = 10...2000
Ziehl	k = 10...1500
Ebm-papst	k = 10...1500
Gebhardt	k = 50...4700

- b. If *Common probe* selected in step 1:

Each common probe has a specific K-value. Select the K-value from common probe manufacturer's specifications.

Available K-value range: 0.001...9999.000



- 4) Select pressure unit for display and output: Pa, kPa, mbar, inWC or mmWC

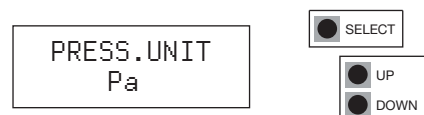

- 5) Pressure output scale (p OUT). Select pressure output scale to improve output resolution.

DPT-Flow-1000	DPT-Flow-2000	DPT-Flow-5000	DPT-Flow-7000
100-1000 Pa	200-2000 Pa	500-5000 Pa	700-7000 Pa
0.1-1.0 kPa	0.2-2.0 kPa	0.5-5.0 kPa	0.7-7.0 kPa
1.0-10 mbar	2.0-20 mbar	5.0-50 mbar	7.0-70 mbar
10-100 mmWC	20-200 mmWC	50-500 mmWC	70-700 mmWC
0.4-4.0 inWC	0.8-8.0 inWC	2.0-20 inWC	2.5-30 inWC

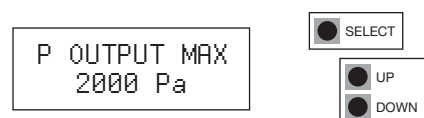

- 6) Select flow unit for display and output:

Flow volume: m<sup>3</sup>/s, m<sup>3</sup>/h, cfm, l/s, none

Velocity: m/s, f/min



## CONFIGURATION CONTINUED

7) Flow output scale (V OUT): Select flow output scale to improve output resolution.

Unit:	Range:
m <sup>3</sup> /s	0.025–50
m <sup>3</sup> /h	100–200,000
cfm	50–100,000
l/s	25–50,000
m/s	1.0–100
f/min	200–20,000

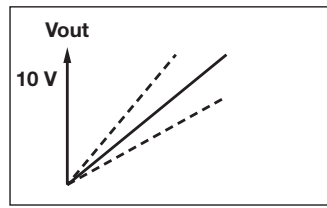

V OUTPUT MAX  
50.000 m<sup>3</sup>/s

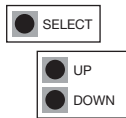

8) Response time: Select response time between 1.0–20 s.

RESPONSE TIME  
20 s

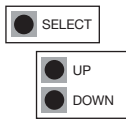

9) Push select button to save changes and to exit menu.

SELECT  
EXIT MENU



## STEP 4: ZEROING THE DEVICE

**NOTE! Always zero the device before use.**

To zero the device two options are available:

- 1) Manual Pushbutton zero point calibration
- 2) Autozero calibration

Does my transmitter have an autozero calibration? See the product label. If it shows -AZ in the model number, then you have the autozero calibration.

- 1) Manual Pushbutton zero point calibration

**NOTE:** Supply voltage must be connected at least one hour prior to zero point adjustment.

- a) Disconnect both pressure tubes from the pressure ports labeled + and -.
- b) Push down the zero button until the LED light (red) turns on and the display reads “zeroing” (display option only). (see figure 3)
- c) The zeroing of the device will proceed automatically. Zeroing is complete when the LED turns off, and the display reads 0 (display option only).
- d) Reinstall the pressure tubes ensuring that the High pressure tube is connected to the port labeled +, and the Low pressure tube is connected to the port labeled -.

Figure 3

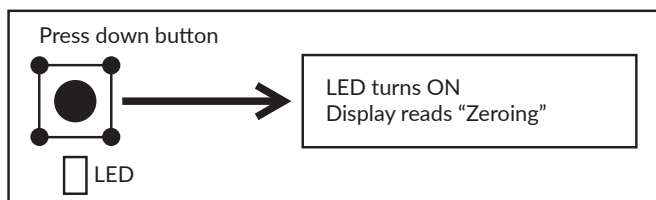

## ZEROING THE DEVICE CONTINUED

- 2) Autozero calibration

If the device includes the optional autozero circuit, no action is required.

Autozero calibration (-AZ) is an autozero function in the form of an automatic zeroing circuit built into the PCB board. The autozero calibration electronically adjusts the transmitter zero at predetermined time intervals (every 10 minutes). The function eliminates all output signal drift due to thermal, electronic or mechanical effects, as well as the need for technicians to remove high and low pressure tubes when performing initial or periodic transmitter zero point calibration. The autozero adjustment takes 4 seconds after which the device returns to its normal measuring mode. During the 4 second adjustment period, the output and display values will freeze to the latest measured value.

Transmitters equipped with the autozero calibration are virtually maintenance free.

## RECYCLING/DISPOSAL

The parts left over from installation should be recycled according to your local instructions. Decommissioned devices should be taken to a recycling site that specializes in electronic waste.



## WARRANTY POLICY

The seller is obligated to provide a warranty of five years for the delivered goods regarding material and manufacturing. The warranty period is considered to start on the delivery date of the product. If a defect in raw materials or a production flaw is found, the seller is obligated, when the product is sent to the seller without delay or before expiration of the warranty, to amend the mistake at his/her discretion either by repairing the defective product or by delivering free of charge to the buyer a new flawless product and sending it to the buyer. Delivery costs for the repair under warranty will be paid by the buyer and the return costs by the seller. The warranty does not comprise damages caused by accident, lightning, flood or other natural phenomenon, normal wear and tear, improper or careless handling, abnormal use, overloading, improper storage, incorrect care or reconstruction, or changes and installation work not done by the seller or his/her authorized representative. The selection of materials for devices prone to corrosion is the buyer's responsibility, unless otherwise is legally agreed upon. Should the manufacturer alter the structure of the device, the seller is not obligated to make comparable changes to devices already purchased. Appealing for warranty requires that the buyer has correctly fulfilled his/her duties arisen from the delivery and stated in the contract. The seller will give a new warranty for goods that have been replaced or repaired within the warranty, however only to the expiration of the original product's warranty time. The warranty includes the repair of a defective part or device, or if needed, a new part or device, but not installation or exchange costs. Under no circumstance is the seller liable for damages compensation for indirect damage.